

**HSF RoHS**

**SPECIFICATIONS  
PERFORMANCE**

Electical Rating: AC/DC 50V 0.5A  
 Insulation Resistance: 500MΩ  
 Withstang Volt: 200V AC/minute  
 Opratng Temperature: -40°C to +105°C  
 Material  
 Contact: Phosphor Bronze  
 Plating: Au or Sn Over Ni  
 Housing: LCP  
 Max.Processing Temp: 260°C±5° 5S

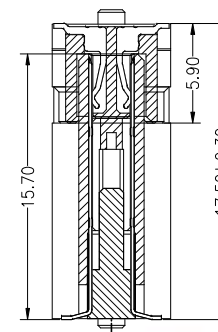
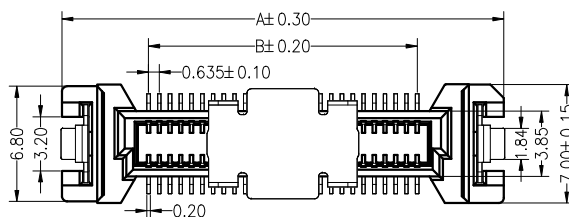

MATING DRAWING(REF.)

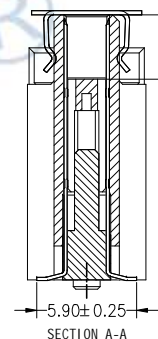
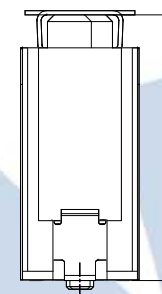
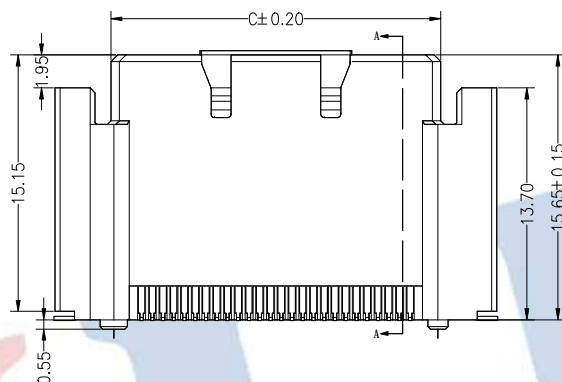

**Ordering Information**

**3722 F XXX 157 XX X X 0X**

F=Female  
 M=Male  
 No.of pins  
 30,40,  
 50,52P  
 Plastic Hight  
 157=15.7mm  
 Contact Plating  
 G0:Gold Flash  
 G1:3U" Gold  
 G2:5U" Gold  
 G3:10U" Gold  
 G4:15U" Gold  
 S0:1.5U" Gold/Tin  
 S1:3U" Gold/Tin  
 Insulator  
 Material  
 Option  
 D=BK-PA46  
 E=BK-PA9T  
 F=BK-LCP  
 Packing  
 T:Tube  
 R:Reel

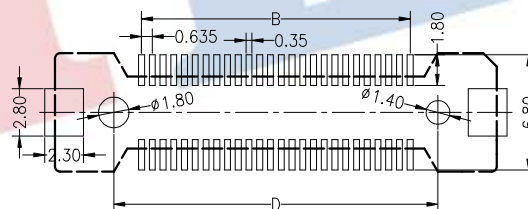
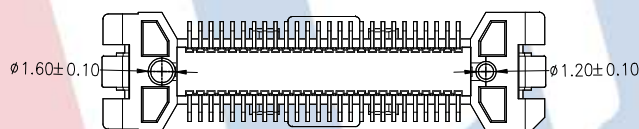

P.C.B Layout

No Of Pins	Dimensions (mm)			
	A	B	C	D
30	19.12	8.89	12.52	12.18
40	22.29	12.07	15.69	15.35
50	25.47	15.24	18.87	18.53
52	26.10	15.88	19.50	19.16

				OPERATION			DRAW	Jelly Feng	2022.12.17	SCALE	FIT	<b>JILN</b> ® 深圳市锦凌电子有限公司 SHENZHEN JINLING ELECTRONICS CO.,LTD Tel : 86-755-2997-5806/5802 Fax: 86-755-2997-5992	
				X.X	±0.30	CHECK				UNIT	mm		
				X.XX	±0.20					APPROVE	SIZE	A4	
				X.XXX	±0.10						PART NO.	SHEET	1/1
A0	2022.12.17	NEW DRAWING		Angle	±3°	TITLE:	PROJ.	1/1					
REV	DATE	MODIFICATION DESCRIPTION		DIM	TOL		0.635mm BTB NPin H15.7 Female (PLC专用)						